

Product Parts Breakdown

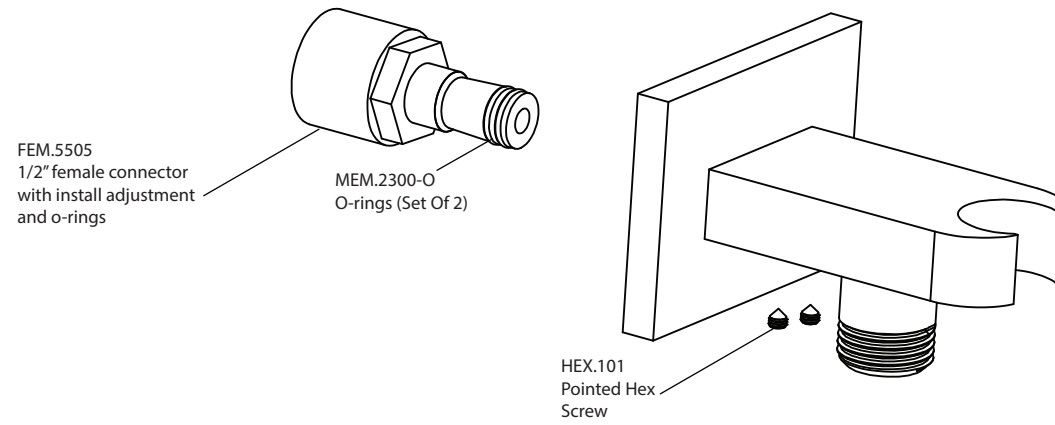

isenberg
innovation+design

HS8007

Ver 2.53